

Owner's Manual

EA-550

PHONO AMPLIFIER

Phasemation

Thank you for purchasing Phasemation product.

Read your Owner's Manual thoroughly for proper operation before starting to use your equipment.

Please keep your Owner's Manual with caution.





Table of Contents

Safety Instructions.....	4
Usage Cautions.....	5
Care of Equipment.....	5
Names and Functions.....	6, 7, 8
Connections.....	9
Trouble Shooting Guide.....	10
User Support.....	11
Specifications.....	11

Safety Instructions

Before starting to use In this owner's manual and on the product, various pictures are used to show our customers how to use Phasemation EA-550 safely and properly in order to avoid the loss of our customer's assets and to protect our customers from harm.

SAFETY PRECAUTIONS

	CAUTION RISK OF ELECTRIC SHOCK DO NOT OPEN	
<p>CAUTION: TO REDUCE THE RISK OF ELECTRIC SHOCK, DO NOT REMOVE COVER (OR BACK). NO USER-SERVICEABLE PARTS INSIDE. REFER SERVICING TO QUALIFIED SERVICE PERSONNEL.</p>		
	The lightning flash with arrowhead symbol, within an equilateral triangle, is intended to alert the user to the presence of uninsulated "dangerous voltage" within the product's enclosure that may be of sufficient magnitude to constitute a risk of electric shock to persons.	
	The exclamation point within an equilateral triangle is intended to alert the user to the presence of important operating and maintenance (servicing) instructions in the literature accompanying the appliance.	
<p>WARNING: TO REDUCE THE RISK OF FIRE OR ELECTRIC SHOCK, DO NOT EXPOSE THIS APPLIANCE TO RAIN OR MOISTURE.</p>		

IMPORTANT SAFETY INSTRUCTIONS

1. Read these instructions.
2. Keep these instructions.
3. Heed all warnings.
4. Follow all instructions.
5. Do not use this apparatus near water.
6. Clean only with dry cloth.
7. Do not block any ventilation openings.
Install in accordance with the manufacturer's instructions.
8. Do not install near any heat sources such as radiators, heat registers, stoves, or other apparatus (including amplifiers) that produce heat.
9. Protect the power cord from being walked on or pinched particularly at plugs, convenience receptacles, and the point where they exit from the apparatus.
10. Only use attachments/accessories specified by the manufacturer.
11. Use only with the cart, stand, tripod, bracket, or table specified by the manufacturer, or sold with the apparatus. When a cart is used, use caution when moving the cart/apparatus combination to avoid injury from tip-over.
12. Unplug this apparatus during lightning storms or when unused for long periods of time.
13. Refer all servicing to qualified service personnel. Servicing is required when the apparatus has been damaged in any way, such as power-supply cord or plug is damaged, liquid has been spilled or objects have fallen into the apparatus, the apparatus has been exposed to rain or moisture, does not operate normally, or has been dropped.
14. Batteries shall not be exposed to excessive heat such as sunshine, fire or the like.



▪ DECLARATION OF CONFORMITY

We declare under our sole responsibility that this product, to which this declaration relates, is in conformity with the following standards:

EN60065, EN55032, EN55020, EN61000-3-2 and EN61000-3-3.

Following the provisions of Low Voltage Directive 2014/35/EU and EMC Directive 2014/30/EU

Usage Cautions

CAUTION:

To completely disconnect this product from the mains, disconnect the plug from the wall socket outlet. The mains plug is used to completely interrupt the power supply to the unit and must be within easy access by the user.

A NOTE ABOUT RECYCLING:

This product's packaging materials are recyclable and can be reused. Please dispose of any materials in accordance with the local recycling regulations.

When discarding the unit, comply with local rules or regulations.

This product and the supplied accessories constitute the applicable product according to the WEEE directive.

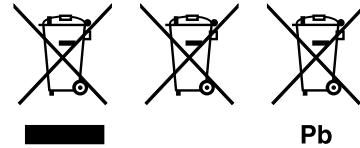

Cautions on installation

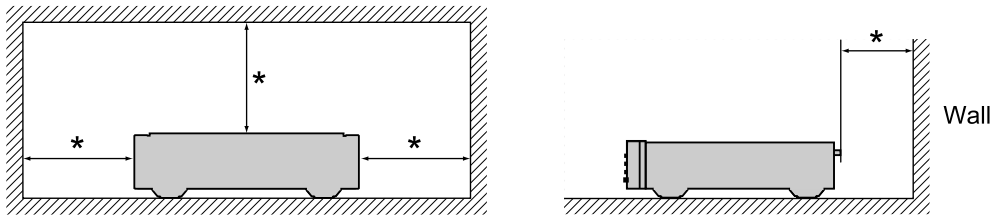

* For proper heat dispersal, do not install this unit in a confined space, such as a bookcase or similar enclosure.

- More than 0.1 m is recommended.
- Do not place any other equipment on this unit.

NOTE ON USE

WARNINGS

- Avoid high temperatures. Allow for sufficient heat dispersion when installed in a rack.
- Handle the power cord carefully. Hold the plug when unplugging the cord.
- Keep the unit free from moisture, water, and dust.
- Unplug the power cord when not using the unit for long periods of time.
- Do not obstruct the ventilation holes.
- Do not let foreign objects into the unit.
- Do not let insecticides, benzene, and thinner come in contact with the unit.
- Never disassemble or modify the unit in any way.
- Ventilation should not be impeded by covering the ventilation openings with items, such as newspapers, tablecloths or curtains.
- Naked flame sources such as lighted candles should not be placed on the unit.
- Observe and follow local regulations regarding battery disposal.
- Do not expose the unit to dripping or splashing fluids.
- Do not place objects filled with liquids, such as vases, on the unit.
- Do not handle the mains cord with wet hands.
- The equipment shall be installed near the power supply so that the power supply is easily accessible.
- Do not keep the battery in a place exposed to direct sunlight or in places with extremely high temperatures, such as near a heater.

Care of Equipment

- ⊙ If the equipment is covered with dust or dirt, clean it with a soft cloth.
- ⊙ If the equipment is very dirty, put detergent which is thinned very well with water on a soft cloth. Wring the cloth and wipe off the dust and dirt. Then clean with a dry soft cloth.
- ⊙ Never use chemical agents such as thinner, naphtha or alcohol when cleaning it. If any of them is attached to the equipment, the silk printing can be flaked or the surface can lose metal luster.

Names and Functions

Front Panel

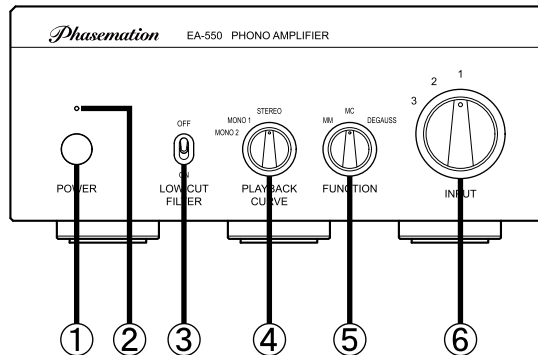

1) POWER Switch

This is the switch to turn the power on/off.

2) POWER Indicator

When the power is turned on, it lights up blue.

Right after the power is turned on, it keeps on blinking until the internal circuit is in a stable condition and sounds will not come out during that time.

3) LOW CUT FILTER Changing Switch

If records with large warps are played, not only the music signals, but unnecessary ultra-low region signals are inputted into the phono amp and the vibration board of the low regional speakers will greatly shake back and forth and this may damage the speakers or distort the sounds. In this case, by turning this switch on, it can attenuate the ultra-low region signals and lessen the above phenomenon.

4) PLAYBACK CURVE Changing Switch

This is the switch that changes the playing equalizer characteristics.

The following three types of playing curves are installed. Switch according to the type of record you want it to play.

-STEREO : RIAA curve for stereo LP playing

-MONO1 : Curve 1 for monaural LP playing (used on a DECCA label and so forth : FFRR)

-MONO2 : Curve 2 for monaural LP playing (used on a Columbia label and so forth)

Electric Characteristics of a Playing Equalizer Curve

Curve	Turnover/Low limit	Roll off
STEREO	500Hz/50Hz(+20dB)	75 μ s-2120Hz(-13.75dB at 10kHz)
MONO 1	500Hz/125Hz(+12-12.5dB)	50 μ s-3000Hz(-10.5dB at 10kHz)
MONO 2	500Hz/100Hz(+14dB)	100 μ s-1590Hz(-16dB at 10kHz)

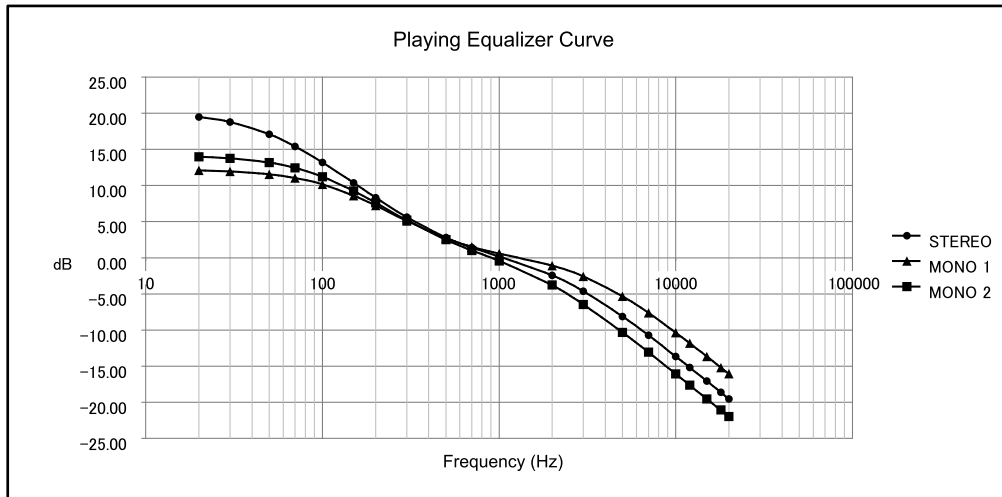

5) FUNCTION Changing Switch

Change according to the type of cartridge used

- MM Select this when using an MM cartridge.
- MC Select this when using an MC stepup transformer.
- MC Select this when using an MC cartridge.
- DEGAUSS This can degauss the MC cartridge that contains magnetized iron core. Select the input that is connected to the MC cartridge with the INPUT switch and let the record play for about 30 seconds. No sounds will come out during this time.

Notice

- When selecting MM, it becomes an unbalanced connection including the XLR connector

6) INPUT Changing Switch

This switch changes the input terminal

- 1) Input Terminal 1 (INPUT1) is selected RCA (unbalanced) / XLR (balanced)
- 2) Input Terminal 2 (INPUT2) is selected RCA (unbalanced) / XLR (balanced)
- 3) Input Terminal 3 (INPUT3) is selected RCA (unbalanced)

Rear Panel (Right)

Rear Panel (Left)

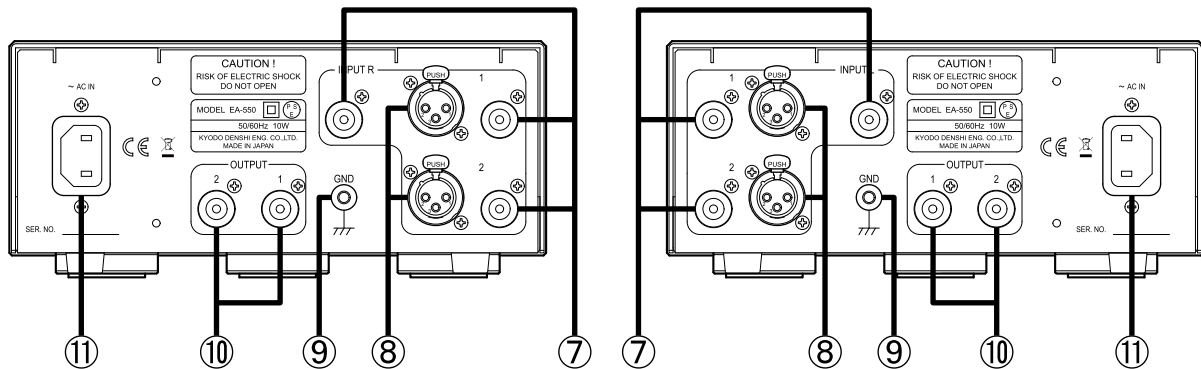

7) INPUT 1,2,3 (RCA) Terminals

Use when the phono cable to be connected is an RCA type connector

8) INPUT 1,2 (XLR) Terminals

Use when the phono cable to be connected is a balanced (XLR) type connector

Notice

- For a balance connection of the XLR terminal, an applicable phono cable is necessary.
- For the XLR terminals, no.1 is GND, no.2 is HOT, and no.3 is COLD.
- Even if the XLR terminal is a balanced connection, if the function is changed to MM, it becomes an unbalanced connection.

Caution

- For INPUT1,2, do not connect the RCA terminal and XLR terminal at the same time.
- Do not insert a short pin to the RCA terminal when using the XLR terminal.
- The XLR terminal is only for an MC cartridge. If a balanced (XLR) output of an MC stepup transformer is connected, it may malfunction.

9) GND Terminal

Connect the earth cable of the analogue disc player to the GND terminal
(see p.9 for the wiring)

10) OUTPUT 1,2 (RCA) Terminals

This is an equalizer output (RCA) terminal of an unbalance. This connects to the line level's RCA input terminal (150-250mV) of a pre-amplifier AUX terminal or so forth.

Caution

Do not connect to a phono input terminal of a pre-amplifier having a phono amplifier inside. It will go to maximum input and sounds will distort.

11) AC IN

The power input terminal connects to the power outlet with the attached AC power cable.

Connections

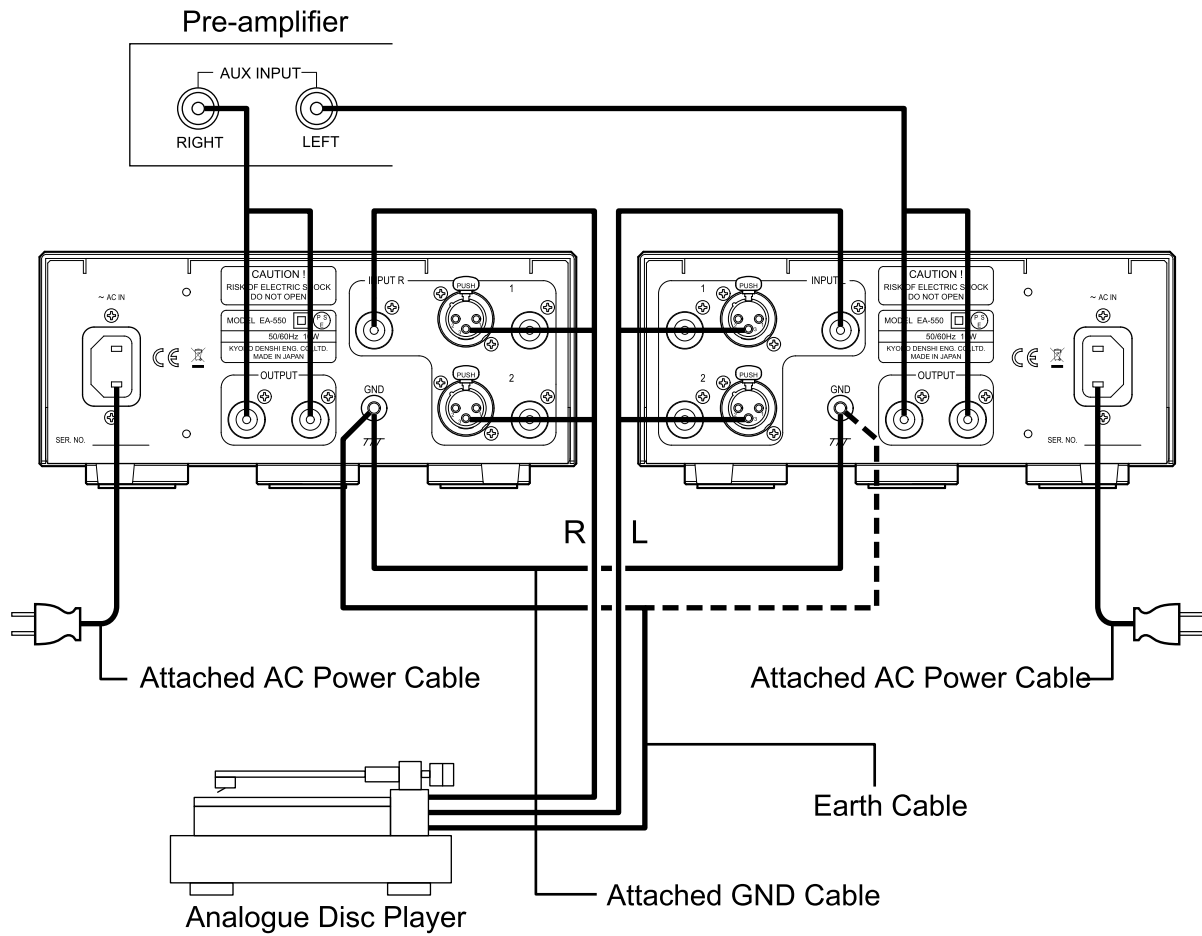

Caution

- For a balance connection of the XLR terminal, an applicable phono cable is necessary.
- For the XLR terminals, no.1 is GND, no.2 is HOT, and no.3 is COLD.

Caution

- For INPUT1,2, do not connect the RCA terminal and XLR terminal at the same time.
- Do not insert a short pin to the RCA terminal when using the XLR terminal.
- The XLR terminal is only for an MC cartridge. If a balanced (XLR) output of an MC stepup transformer is connected, it may malfunction.

Trouble Shooting Guide

In case the equipment does not operate properly, check out the followings.

If it does not operate properly even after checking the advised points, disconnect the AC plug from the outlet and then contact the dealer.

Trouble	Causes	Measures
The power is not supplied	<ul style="list-style-type: none"> ● The plug of the AC power cable is not plugged in completely. 	<ul style="list-style-type: none"> ● Insert the plug of the AC cable into an outlet firmly. ● Firmly insert the AC power cable into the AC inlet of the power equipment.
The sound is not heard	(1) The audio wires are not plugged in completely.	<ul style="list-style-type: none"> ● Insert the audio wires completely.
	(2) The connected INPUT terminal and INPUT changing switch do not match.	<ul style="list-style-type: none"> ● Correctly match the INPUT terminal and INPUT changing switch.
	(3) The type of cartridge used and the FUNCTION changing switch do not match.	<ul style="list-style-type: none"> ● Match the FUNCTION changing switch (MM/MC) to the cartridge (MM/MC) to be used.
	(4) The FUNCTION changing switch is set to DEGAUSS.	
	(5) Although a balanced input is used, a short pin is inserted to the unbalanced input (RCA).	<ul style="list-style-type: none"> ● Remove the short pin from the unbalanced input terminal.
	(6) A balanced (XLR) output of an MC stepup transformer is connected to the balanced (XLR) input.	<ul style="list-style-type: none"> ● Does not support balanced (XLR) outputs of MC stepup transformers. Connect as unbalanced (RCA).
The sound is distorted	<ul style="list-style-type: none"> ● The outputs of this equipment are connected to the input terminals for a phono amplifier on the panel of the pre-amplifier. 	<ul style="list-style-type: none"> ● Connect them to line level input terminals (such as AUX) of the pre-amplifier.
When operating the function switch, the click noise is heard	<ul style="list-style-type: none"> ● Some click tone is generated because of the switch principle. 	<ul style="list-style-type: none"> ● Before operating the switches, turn the power of this equipment off or decrease the volume of the connected amplifier.
A hum noise is heard	<ul style="list-style-type: none"> ● The audio wires are not plugged in completely. ● The earth cable from the analogue disc player is not connected. ● A power supply transformer or motor in another equipment is placed near this equipment. 	<ul style="list-style-type: none"> ● Insert the audio wires completely. ● Connect the earth cable completely. ● Place this equipment apart from a power supply transformer or a motor of another equipment.
The sound is not heard immediately after turning the power on	<ul style="list-style-type: none"> ● The sound is not outputted until the circuits come to stable operation. 	<ul style="list-style-type: none"> ● Please wait till the power indicator will change from flashing to lighting up.

User Support

As for the unclear matters with regards to the after service, please contact the dealer.

Specifications

Product	V-I/I-V Converting Type Complete Full Symmetrical and Non-Feedback Type Phono Amplifier	
Cartridge Type	MM	MC
Input Sensitivity	2.5mV	0.13mV
Applicable Cartridge Impedance	47k Ω or less	1.5-40 Ω
Gain	38dB	64dB
Input Referred S/N Ratio	-120dB	-140dB
Rated Output Voltage	200mV (1kHz)	
Deviation from RIAA Curve	\pm 0.5dB (20Hz~20kHz)	
Output Impedance	47 Ω	
Power Requirement	AC120V 60Hz (U.S.A) AC230V 50/60Hz (Europe)	
Power Consumption	10W for each ch	
Dimensions (mm)	211 (W) \times 93 (H) \times 360 (D)	
Weight	5.5kg for each ch	

Accessories : AC power cable x 2, GND cable x 1

The appearance and specifications of this equipment are subject to change without notice in order to improve it.

Phasemation

Kyodo Denshi Engineering Co., Ltd.

8-40-17 Shinyoshidahigashi Kohoku-ku Yokohama-shi Kanagawa 223-0058 Japan

TEL 81-45-710-0975

FAX 81-45-710-0976

E-mail info@phasemation.com

URL <http://phasemation.com>

Phasemation is the original audio brand of Kyodo Denshi Engineering Co., Ltd.